

## Pressure Compensated Flow Control Valves

F(C)G-3, 10 Series; ISO 4401, Size 03/NFPA D01

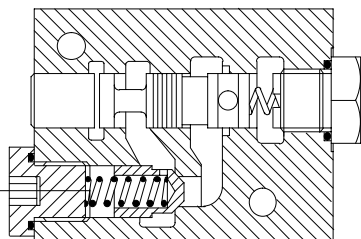
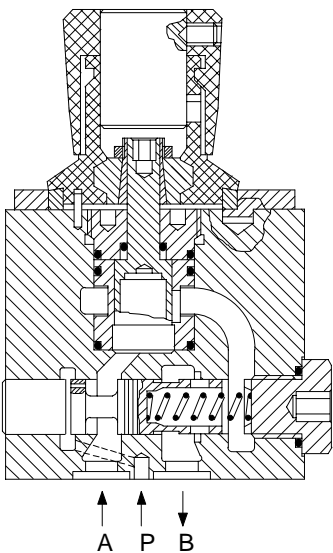

### General Description

These pressure compensated valves are designed to provide adjustable controlled flow rates independent of changes in inlet and/or outlet pressures above a minimum pressure differential. Models are available with or without integral reverse flow check valves. Those with check valves are optionally available with an anti-jump feature designed to eliminate transient surges above the controlled flow rate setting whenever flow is first directed to the inlet port A.

All models have rotary adjustment of controlled flow and can be supplied with or without an integral key-lock feature.

The construction of a typical model with integral check valve and anti-jump feature is shown opposite. Its operation is the same as for similar valves described in the "Industrial Hydraulics" manual although the spring-loaded hydrostat is functionally located downstream of the adjustable restrictor, as shown in the "Functional Symbols" section.

### Functional Symbols

FCG-3-\*\*\*-10 models, without reverse flow check

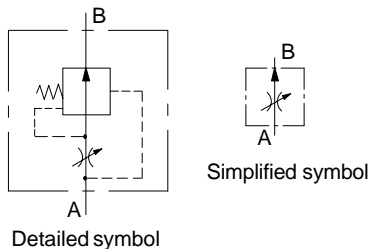

FCG-3-\*\*\*-A\*-10 models, with reverse flow check and anti-jump feature

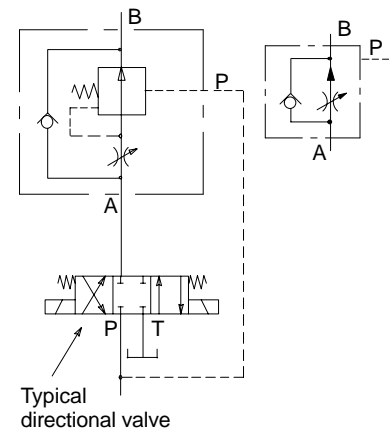

FCG-3-\*\*\*-10 models, with reverse flow check

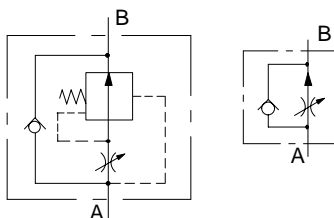

### Basic Characteristics

- Max. flow rates . . . . . 1,0 to 18 L/min (0.42 to 4.75 USgpm), dependent on model
- Max. pressure . . . . . 315 (4500 psi) or 160 bar (2325 psi), dependent on model
- Functions . . . . . In line, with or without reverse flow check and anti-jump feature

*Note: FCG-3-\*\*\*-A models are designed primarily for meter-in applications where the P port can be connected to an upstream point that provides continuous pilot pressure to the hydrostat to prevent "jump". Consult your Vickers representative about alternative applications.*

## Model Code

### F(C)G-3-\*\*\*(-A)-\*-10

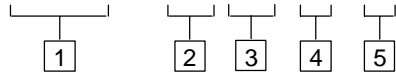

#### 1 Type

FCG= Flow control with reverse flow check  
 FG = Flow control without reverse flow check

#### 2 Max. controlled flow rate

10 = 1,0 L/min (0.26 USgpm)  
 16 = 1,6 L/min (0.42 USgpm)  
 32 = 3,2 L/min (0.85 USgpm)  
 63 = 6,3 L/min (1.66 USgpm)  
 120 = 12,0 L/min (3.17 USgpm)  
 180 = 18,0 L/min (4.75 USgpm)

#### 3 Anti-jump feature (FCG model option)

Omit when not required and for all FG models.

#### 4 Controlled flow adjustment

H = Manual without key lock  
 K = Manual with key lock

#### 5 Design number, 10 series

Subject to change. Installation dimensions remain unchanged for design numbers 10-19 inclusive.

## Operating Data

### Pressure Limits

Max. pressure, all ports: FCG-3-***-A models All other models	160 bar (2320 psi) 315 bar (4500 psi)
Min. pressure differential for effective controlled flow (port A pressure > port B pressure): F(C)G-3-10/16/32 models F(C)G-3-63/120/180 models	5 bar (75 psi) 8,5 bar (125 psi)

### Flow Limits

Recommended controlled flow ranges: F(C)G-3-10 F(C)G-3-16 F(C)G-3-32 F(C)G-3-63 F(C)G-3-120 F(C)G-3-180	0,015 to 1,0 L/min (0.004 to 0.26 USgpm) 0,015 to 1,6 L/min (0.004 to 0.42 USgpm) 0,025 to 3,2 L/min (0.007 to 0.85 USgpm) 0,025 to 6,3 L/min (0.007 to 1.66 USgpm) 0,08 to 12,0 L/min (0.02 to 3.17 USgpm) 0,08 to 18,0 L/min (0.02 to 4.75 USgpm)
Max. recommended reverse flow (FCG model)	30 L/min (7.9 USgpm)

### Applications

FG-3 models are for general use in meter-in, meter-out or bleed-off applications.  
 FCG-3-\*\*\*-10 models are for general use in meter-in or meter-out applications in which high reverse flow rates can occur.

FCG-3-\*\*\*-A-10 models are for similar use in those meter-in applications where the possibility of transient surges above the controlled flow rate setting, whenever flow is first directed to the inlet port, is undesirable, e.g.  
 – for feed speed control  
 – for successive fast approach/feed sequences (fine machining of interrupted bores).

# Performance Data

Typical with petroleum oil at 36 cSt (170 SUS) and at 50°C (122°F)

## Controlled Flow, F(C)G-3-16/32 Models

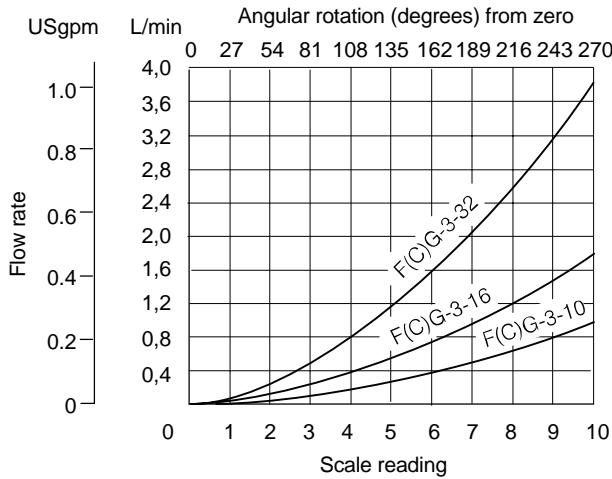

## Controlled Flow, F(C)G-3-63/120/180 Models

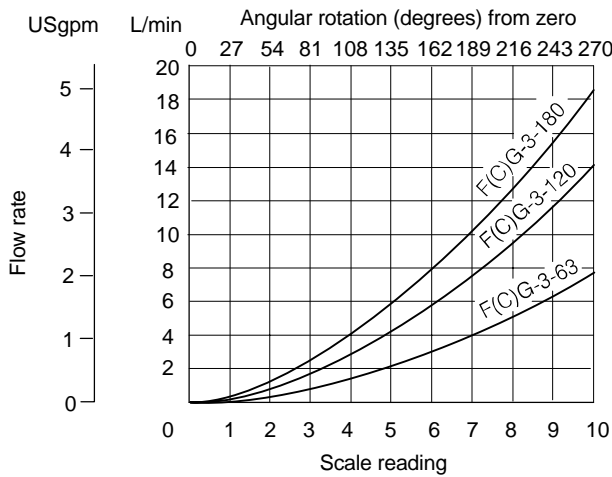

## Reverse Flow Pressure Drop, FCG Models

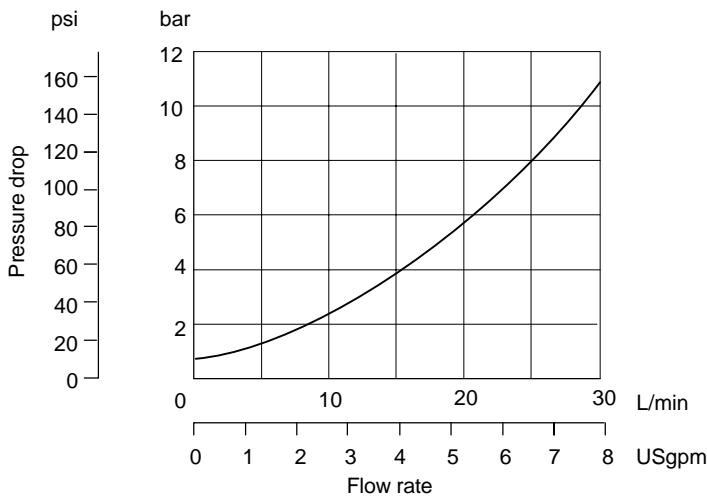

Thermal stability of controlled flow, typical example:

Flow set at 20°C (68°F) . . . . . 0,25 L/min (0.07 USgpm)

Flow increase at 70°C (158°F) . . . . . +12%

## Hydraulic Fluids

All valves can be used with antiwear or other hydraulic petroleum oils. If fire-resistant fluids are required to be used, consult your Vickers representative. The extreme operating viscosity range is from 300 to 10 cSt (1460 to 54 SUS) but the recommended running range is from 54 to 13 cSt (245 to 70 SUS). For further information fluids see catalog 920.

## Temperature Limits

Min. . . . . -20°C (-4°F)

Max.\* . . . . . +80°C (176°F)

\* To obtain optimum service life from both fluid and hydraulic system, 65°C (150°F) is normally the maximum temperature for hydraulic petroleum oils.

Whatever the actual temperature range, ensure that the viscosities stay within the limits specified in the "Hydraulic Fluids" section.

## Contamination Control Requirements

Recommendations on contamination control methods and the selection of products to control fluid condition are included in Vickers publication 9132 or 561, "Vickers Guide to Systemic Contamination Control". The book also includes information on the Vickers concept of "ProActive Maintenance". The following recommendations are based on ISO cleanliness levels at 2 µm, 5 µm and 15 µm. For products in this catalog the recommended levels are:

Up to 210 bar (3050 psi) . . . . . 19/17/14

Above 210 bar (3050 psi) . . . . . 19/17/14

# Installation Dimensions in mm (inches)

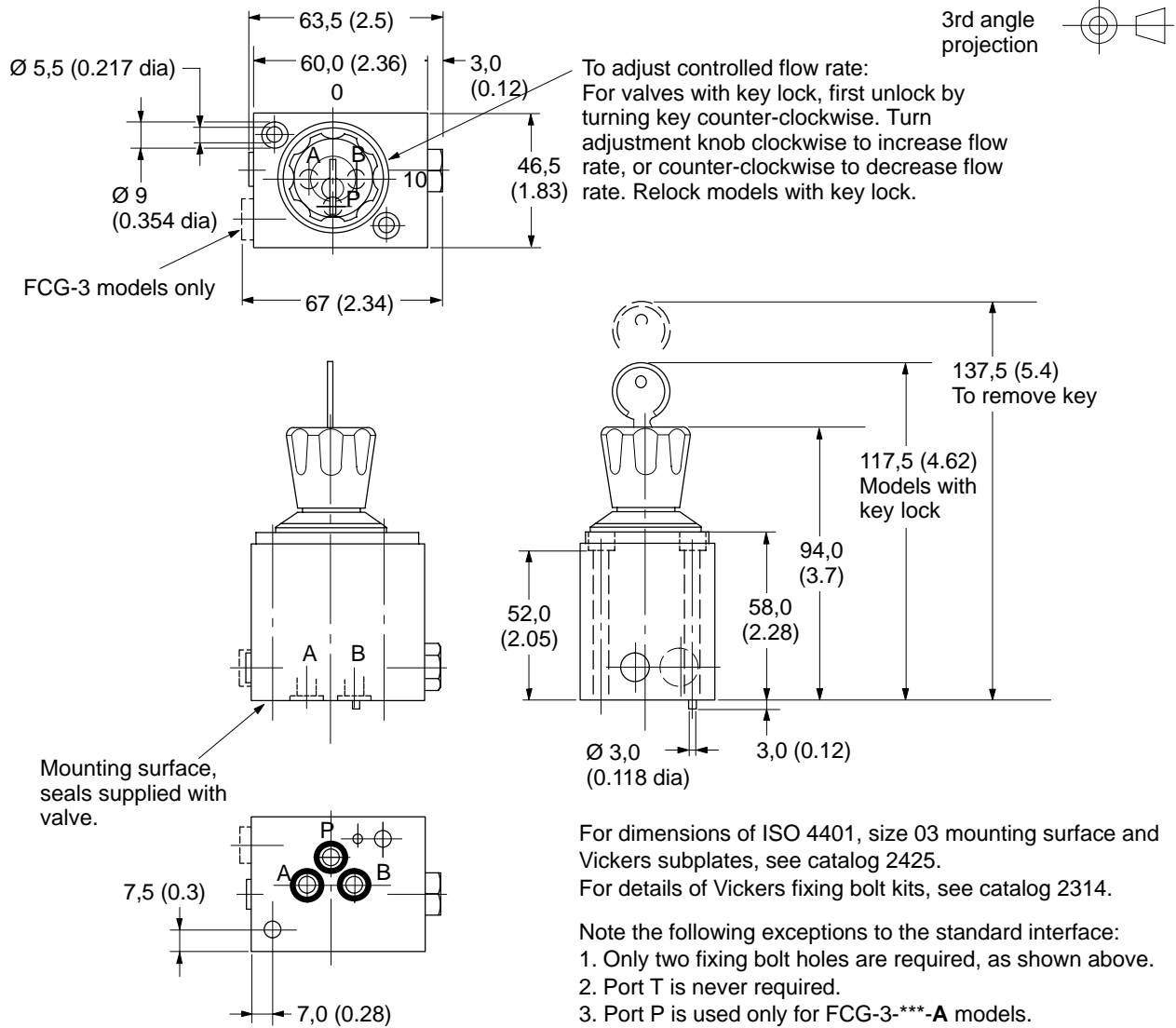

## Mass

All models . . . . . 1,1 kg (2.4 lb) approx.

## Installation Data

### Mounting Attitude

Unrestricted

### Mounting Surface, Subplates and Fixing Bolts

See note in "Installation Dimensions" section. F(C)G-3 valves cannot be used to top normal ISO 4401 size 03/NFPA D01 module stacks unless the application will be satisfactory with a two-bolt fixing and with the two or three-port arrangements of the F(C)G-3 valves; consult your Vickers

representative if such an arrangement is required.

A two-bolt fixing kit BK 986743M containing M5 x 60 long soc. hd. cap screws is available separately for securing an F(C)G-3 valve direct to a subplate.

## Ordering Procedure

Valves and fixing bolt kits must be ordered as separate items e.g.  
2 off FCG-3-120-A-K-10 valve  
2 off BK 986743M bolt kit

## Service and Repair

The construction of these valves is such that the only spare parts available are the mounting surface seals (kit no. 986742 containing three seals). Experience shows that the only servicing likely to be needed is the possibility to dismantle the spring-loaded hydrostat for cleaning in cases where contaminant has accumulated through continuous use in less than ideal environments. For details see "Spare Parts" leaflet 40594.