

JIC 37° Flare-Twin®

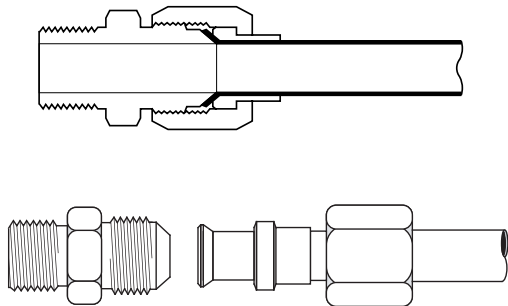

Tube O.D.	1/8	3/16	1/4	5/16	3/8	1/2	5/8
Thread	5/16-24	3/8-24	7/16-20	1/2-20	9/16-18	3/4-16	7/8-14

Tube O.D.	3/4	7/8	1	1-1/4	1-1/2	2
Thread	1-1/16-12	1-3/16-12	1-5/16-12	1-5/8-12	1-7/8-12	2-1/2-12

Typical Application: Hydraulic, instrumentation and chemical processing systems.

Pressure: See chart.

Sealing Method: 37° flare; 2- or 3-piece assembly.

Vibration Rating: Good resistance.

Material: Carbon steel – AISI/SAE 12L14
Stainless steel – Type 316

Plating: Zinc; yellow dichromate finish.

Used With: Copper, brass, steel, aluminum, and other tubing that can be flared.

Advantages: Zinc plate. Choice of 2- or 3-piece design. Broad selection of styles and sizes. Interchangeable with all sources.

Identifying Characteristics: 2-piece flare has long nut. 3-piece flare has a short nut with the sleeve protruding. Material is generally steel or stainless steel.

Conformance: Meets ASA, ASME, SAE.

Ordering Information: To order a 3-piece assembly – Prefix the catalog number with a “3.” Example: To order a male connector C5205x4 with nut and sleeve assembled, order C35205x4. Order bodies, nuts, and sleeves separately by catalog number.

Label Set: FS-200

NOTE: See page 377 for hydraulic o-ring assortment.

Forged Fittings and Adaptors

5000 Series Pressure Rating Chart

CONNECTIONTYPE	END SIZE												
	1/8"	3/16"	1/4"	5/16"	3/8"	1/2"	5/8"	3/4"	7/8"	1"	1-1/4"	1-1/2"	2"
SAE FITTINGS	6000	5000	5000	5000	5000	4000	4000	4000	4000	4000	3000	3000	3000
W/ADJUSTABLE STRAIGHT THREAD O-RING	5000	5000	4500	4000	4000	4000	3000	3000	2500	2500	2000	1500	1125
WITH MALE PIPE	6000		5000		5000	4000		4000		4000	3000	2500	2500
WITH FEMALE PIPE	5000		5000		4000	3000		2500		2000	1500	1500	1000

Brazed Fittings (TF)/SAE

5000 Series Pressure Rating Chart

CONNECTIONTYPE	END SIZE												
	1/8"	3/16"	1/4"	5/16"	3/8"	1/2"	5/8"	3/4"	7/8"	1"	1-1/4"	1-1/2"	2"
SAE FITTINGS	5000	5000	4500	4000	4000	4000	3000	3000	2500	2500	2000	1500	1125
W/ADJUSTABLE STRAIGHT THREAD O-RING	5000	5000	4500	4000	4000	4000	3000	3000	2500	2500	2000	1500	1125
WITH MALE OR FEMALE PIPE	5000	5000	5000	5000	4000	3000	3000	2500	2500	2000	1150	1000	1000

JIC 37° Flare-Twin®

Sleeve 3-Piece
(Ref. SAE No. 070115)

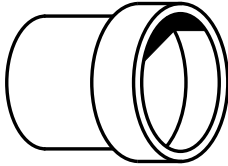

TUBE O.D.	CATALOG NUMBER
1/8	C5165x2□
3/16	C5165x3□
1/4	C5165x4□
5/16	C5165x5□
3/8	C5165x6□
1/2	C5165x8□
5/8	C5165x10□
3/4	C5165x12□
7/8	C5165x14
1	C5165x16□
1-1/4	C5165x20□
1-1/2	C5165x24□
2	C5165x32□

*5177x

Sleeve 3-Piece Metric
(Ref. SAE No. 070115)

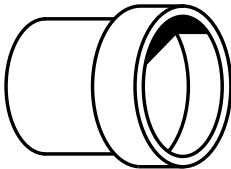

TUBE O.D.(IN)	TUBE O.D.(MM)	CATALOG NUMBER
1/4	6MM	C5165x4x6MM
5/16	8MM	C5165x5x8MM
3/8	10MM	C5165x6x10MM
1/2	12MM	C5165x8x12MM
5/8	14MM	C5165x10x14MM
5/8	15MM	C5165x10x15MM
5/8	16MM	C5165x10x16MM
3/4	18MM	C5165x12x18MM
7/8	20MM	C5165x14x20MM
7/8	22mm	C5165x14x22MM
1	25MM	C5165x16x25MM
1-1/4	30MM	C5165x20x30MM
1-1/4	32MM	C5165x20x32MM
1-1/2	38MM	C5165x24x38MM

Adapts standard SAE Flare-Twin®
Fittings for use with Metric Tubing.

Nut 3-Piece
(Ref. SAE No. 070110)

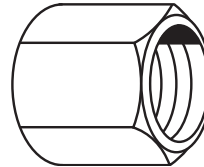

TUBE O.D.	CATALOG NUMBER
1/8	C5105x2□
3/16	C5105x3□
1/4	C5105x4□
5/16	C5105x5□
3/8	C5105x6□
1/2	C5105x8□
5/8	C5105x10□
3/4	C5105x12□
7/8	C5105x14
1	C5105x16□
1-1/4	C5105x20□
1-1/2	C5105x24□
2	C5105x32□

*5117x

2-Piece Nut
(Ref. SAE No. 070111)

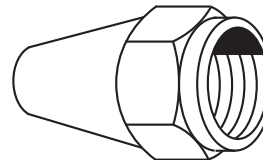

TUBE O.D.	CATALOG NUMBER
1/4	C5115x4
5/16	C5115x5
3/8	C5115x6
1/2	C5115x8
5/8	C5115x10
3/4	C5115x12
7/8	C5115x14
1	C5115x16
1-1/4	C5115x20
1-1/2	C5115x24

2-Piece Nut (Short)

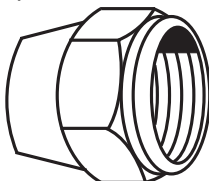

TUBE O.D.	CATALOG NUMBER
1/4	C5125x4
5/16	C5125x5
3/8	C5125x6
1/2	C5125x8
5/8	C5125x10
3/4	C5125x12

*Stainless steel catalog number.
□ Available in Stainless Steel.

JIC 37° Flare-Twin®

Bulkhead Nut (Ref. SAE No. 070118)

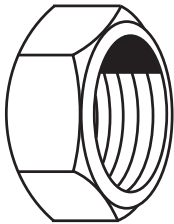

TUBE O.D.	CATALOG NUMBER
1/8	C5924x2
3/16	C5924x3
1/4	C5924x4□
5/16	C5924x5
3/8	C5924x6□
1/2	C5924x8□
5/8	C5924x10
3/4	C5924x12□
7/8	C5924x14
1	C5924x16□
1-1/4	C5924x20
1-1/2	C5924x24
2	C5924x32

*7936x

Cap (Ref. SAE No. 070112)

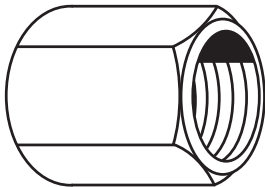

TUBE O.D.	CATALOG NUMBER
1/8	C5129x2
3/16	C5129x3
1/4	C5129x4□
5/16	C5129x5□
3/8	C5129x6□
1/2	C5129x8□
5/8	C5129x10□
3/4	C5129x12□
1	C5129x16□
1-1/4	C5129x20□
1-1/2	C5129x24
2	C5129x32

*5141x

Seal-Nut For Male Pipe Thread

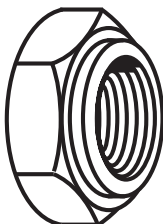

PIPE THREAD	CATALOG NUMBER
1/8	C3059x2
1/4	C3059x4
3/8	C3059x6
1/2	C3059x8
3/4	C3059x12
1	C3059x16

Reducer (Ref. SAE No. 070123) Assembly No. C35015x, etc.

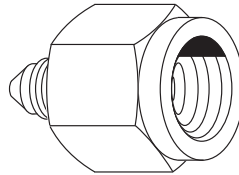

(# one-piece design)

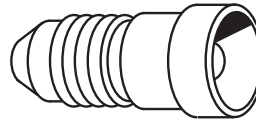

(two-piece design)

TUBE A REDUCE	TUBE B REDUCE	CATALOG NUMBER
3/8	1/4	C5015x6x4□
1/2	1/4	C5015x8x4□
1/2	3/8	C5015x8x6□
5/8	1/4	C5015x10x4#□
5/8	3/8	C5015x10x6#□
5/8	1/2	C5015x10x8#□
3/4	1/4	C5015x12x4□
3/4	3/8	C5015x12x6□
3/4	1/2	C5015x12x8□
3/4	5/8	C5015x12x10#
7/8	3/8	C5015x14x6#
7/8	1/2	C5015x14x8#
7/8	5/8	C5015x14x10#
7/8	3/4	C5015x14x12#
1	1/2	C5015x16x8#
1	5/8	C5015x16x10#
1	3/4	C5015x16x12□
1	7/8	C5015x16x14#
1-1/4	3/4	C5015x20x12
1-1/4	1	C5015x20x16#
1-1/2	1-1/4	C5015x24x20#
2	1-1/2	C5015x32x24#

Note: Order 3-piece nut C5105X to use reducer. No sleeve necessary. *5027x

Male Straight Thread O-Ring Hex Socket Plug (Ref. SAE No. 090109B)

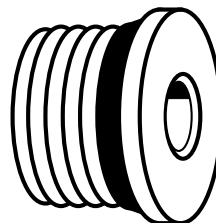

PORT SIZE	CATALOG NUMBER
1/8	7238x2
3/16	7238x3
1/4	7238x4
5/16	7238x5
3/8	7238x6
1/2	7238x8
5/8	7238x10
3/4	7238x12
7/8	7238x14
1	7238x16
1-1/4	7238x20

NOTE: Parts furnished with zinc plate.

*Stainless steel catalog number.
□ Available in Stainless Steel.

JIC 37° Flare-Twin®

Male Straight Thread O-Ring Hex Head Plug (Ref. SAE No. 090109A)

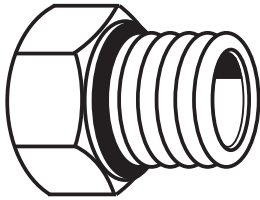

PORT SIZE	CATALOG NUMBER
1/8	7237x2#
3/16	7237x3#
1/4	7237x4#
5/16	7237x5#
3/8	7237x6#
1/2	7237x8#
5/8	7237x10#
3/4	7237x12#
7/8	7237x14#
1	7237x16
1-1/4	7237x20
1-1/2	7237x24
2	7237x32

NOTE: Parts furnished with zinc plate.
#Not counterbored.

Male Straight Thread/ Female Straight Thread O-Ring Boss

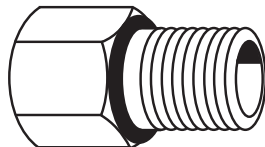

MALE PORT SIZE	FEMALE PORT SIZE	CATALOG NUMBER
1/2	3/8	7033x8x6
5/8	1/2	7033x10x8
3/4	1/2	7033x12x8
7/8	3/4	7033x14x12
1	1/2	7033x16x8
1	3/4	7033x16x12
1-1/4	3/4	7033x20x12
1-1/2	1-1/4	7033x24x20
2	1-1/2	7033x32x24

NOTE: Parts furnished with zinc plate.

Large Hex Union (Ref. SAE No. 070119) Assembly Number C35306x4, etc.

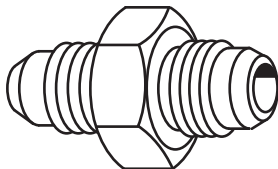

TUBE O.D.	CATALOG NUMBER
1/4	C5306x4□
5/16	C5306x5□
3/8	C5306x6□
1/2	C5306x8□
5/8	C5306x10□
3/4	C5306x12□
1	C5306x16□
1-1/4	C5306x20
1-1/2	C5306x24

*5318x • 5318x6x4, 5318x8x6

Small Hex Union (Ref. SAE No. 070101) Assembly Number C35305x4, etc.

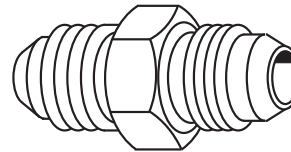

TUBE O.D.	TUBE O.D.	CATALOG NUMBER
1/8	1/8	C5305x2
3/16	3/16	C5305x3
1/4	1/4	C5305x4□
5/16	1/4	C5305x5x4
5/16	5/16	C5305x5□
3/8	1/4	C5305x6x4
3/8	5/16	C5305x6x5
3/8	3/8	C5305x6□
1/2	3/8	C5305x8x6
1/2	1/2	C5305x8□
5/8	1/2	C5305x10x8
5/8	5/8	C5305x10□
3/4	1/2	C5305x12x8
3/4	5/8	C5305x12x10
3/4	3/4	C5305x12□
7/8	7/8	C5305x14
1	3/4	C5305x16x12
1	1	C5305x16□
1-1/4	1-1/4	C5305x20
1-1/2	1-1/2	C5305x24
2	2	C5305x32

*5317x

Male Straight Thread O-Ring Union

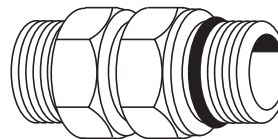

PORT SIZE	CATALOG NUMBER
1/4	C5314x4x4
3/8	C5314x6x6
1/2	C5314x8x8
5/8	C5314x10x10
3/4	C5314x12x12
1	C5314x16x16
1-1/4	C5314x20x20
1-1/2	C5314x24x24
2	C5314x32x32

*Stainless steel catalog number.
□ Available in Stainless Steel.
• Available in Stainless Steel Only.

JIC 37° Flare-Twin®

Bulkhead Union (Ref. SAE No. 070601) Assembly Number C35325x4, etc.

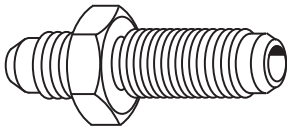

TUBE O.D.	CATALOG NUMBER
3/16	C5325x3
1/4	C5325x4□
5/16	C5325x5
3/8	C5325x6□
1/2	C5325x8□
5/8	C5325x10□
3/4	C5325x12□
3/4	C5325x12BN□
1	C5325x16
1-1/4	C5325x20

*5337x

For bulkhead nut see page 270.
Included with assembly.

Adapter

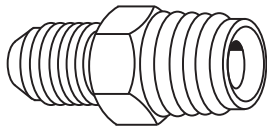

TUBE O.D.	INVERTED THREAD	CATALOG NUMBER
1/4	7/16-24	C5880x4
5/16	1/2-20	C5880x5
3/8	5/8-18	C5880x6
1/2	3/4-18	C5880x8

Female Bulkhead Connector Assembly Number C35725x4, etc.

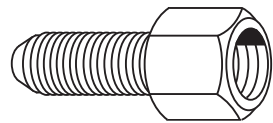

TUBE O.D.	FEMALE PIPE THREAD	CATALOG NUMBER
1/4	1/8	C5275x4
3/8	1/4	C5275x6
1/2	3/8	C5275x8
5/8	1/2	C5275x10
3/4	3/4	C5275x12
1	1	C5275x16

For bulkhead nut see page 270.
Included with assembly.

Male Connector (Ref. SAE No. 070102) Assembly Number C35205x4, etc.

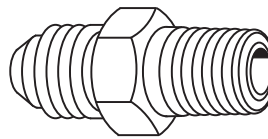

TUBE O.D.	MALE PIPE THREAD	CATALOG NUMBER
1/8	1/8	C5205x2□
3/16	1/8	C5205x3
1/4	1/8	C5205x4□
1/4	1/4	C5205x4x4□
1/4	3/8	C5205x4x6
1/4	1/2	C5205x4x8
5/16	1/8	C5205x5
5/16	1/4	C5205x5x4□
5/16	3/8	C5205x5x6
3/8	1/8	C5205x6x2□
3/8	1/4	C5205x6□
3/8	3/8	C5205x6x6□
3/8	1/2	C5205x6x8□
1/2	1/4	C5205x8x4□
1/2	3/8	C5205x8□
1/2	1/2	C5205x8x8□
1/2	3/4	C5205x8x12□
5/8	3/8	C5205x10x6
5/8	1/2	C5205x10□
5/8	3/4	C5205x10x12
3/4	1/2	C5205x12x8□
3/4	3/4	C5205x12□
3/4	1	C5205x12x16
7/8	3/4	C5205x14
1	3/4	C5205x16x12
1	1	C5205x16□
1	1-1/4	C5205x16x20
1-1/4	1	C5205x20x16
1-1/4	1-1/4	C5205x20
1-1/2	1-1/4	C5205x24x20
1-1/2	1-1/2	C5205x24
2	2	C5205x32

*5217x

*Stainless steel catalog number. □Standard part is bagged and includes nut.
□ Available in Stainless Steel.

JIC 37° Flare-Twin®

Female Connector
(Ref. SAE No. 070103)
Assembly Number
C35255x4, etc.

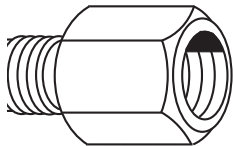

TUBE O.D.	FEM. PIPE THREAD	CATALOG NUMBER
1/8	1/8	C5255x2
3/16	1/8	C5255x3
1/4	1/8	C5255x4□
1/4	1/4	C5255x4x4□
5/16	1/8	C5255x5
5/16	1/4	C5255x5x4□
3/8	1/4	C5255x6□
3/8	3/8	C5255x6x6□
1/2	3/8	C5255x8□
1/2	1/2	C5255x8x8□
5/8	3/8	C5255x10x6
5/8	1/2	C5255x10□
3/4	1/2	C5255x12x8□
3/4	3/4	C5255x12□
7/8	3/4	C5255x14
1	1	C5255x16□
1-1/4	1-1/4	C5255x20
1-1/2	1-1/2	C5255x24
2	2	C5255x32

*5267x

Straight Thread O-Ring Extended Connector
(Ref. SAE No. 070122)
Assembly Number C35316x4, etc.

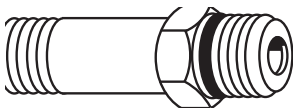

TUBE O.D.	PORT SIZE	CATALOG NUMBER
1/4	1/4	C5316x4
3/8	3/8	C5316x6
1/2	1/2	C5316x8
1/2	3/8	C5316x8x6
5/8	5/8	C5316x10
3/4	3/4	C5316x12
1	1	C5316x16
1-1/4	1-1/4	C5316x20

Straight Thread O-Ring Connector
(Ref. SAE No. 070120)
Assembly Number
C35315x4, etc.

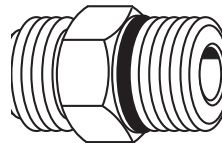

*5327x

TUBE O.D.	PORT SIZE	CATALOG NUMBER
1/8	1/8	C5315x2□
3/16	3/16	C5315x3
1/4	1/4	C5315x4□
1/4	5/16	C5315x4x5□
1/4	3/8	C5315x4x6
1/4	1/2	C5315x4x8
5/16	1/4	C5315x5x4
5/16	5/16	C5315x5
5/16	3/8	C5315x5x6
3/8	1/4	C5315x6x4
3/8	5/16	C5315x6x5
3/8	3/8	C5315x6□
3/8	1/2	C5315x6x8□
3/8	5/8	C5315x6x10
1/2	3/8	C5315x8x6
1/2	1/2	C5315x8□
1/2	5/8	C5315x8x10□
1/2	3/4	C5315x8x12□
5/8	1/2	C5315x10x8
5/8	5/8	C5315x10□
5/8	3/4	C5315x10x12
5/8	1	C5315x10x16
3/4	1/2	C5315x12x8
3/4	5/8	C5315x12x10
3/4	3/4	C5315x12□
3/4	7/8	C5315x12x14
3/4	1	C5315x12x16
3/4	1-1/4	C5315x12x20
7/8	7/8	C5315x14
1	5/8	C5315x16x10
1	3/4	C5315x16x12
1	1	C5315x16□
1	1-1/4	C5315x16x20
1-1/4	1	C5315x20x16
1-1/4	1-1/4	C5315x20
1-1/4	1-1/2	C5315x20x24
1-1/2	1-1/4	C5315x24x20
1-1/2	1-1/2	C5315x24
1-1/2	2	C5315x24x32
2	1-1/2	C5315x32x24
2	2	C5315x32

*Stainless steel catalog number.
□ Available in Stainless Steel.

JIC 37° Flare-Twin®

Male 37° JIC to Male Metric Standpipe

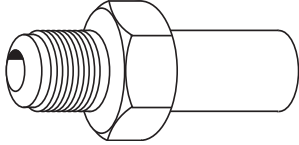

TUBE O.D.	TUBE O.D. (MM)	CATALOG NUMBER
1/4	6MM	MC5019x4x6
1/4	8MM	MC5019x4x8
3/8	10MM	MC5019x6x10
1/2	12MM	MC5019x8x12
1/2	14MM	MC5019x8x14
5/8	15MM	MC5019x10x15
5/8	16MM	MC5019x10x16
3/4	16MM	MC5019x12x16
3/4	18MM	MC5019x12x18
3/4	20MM	MC5019x12x20
1	22MM	MC5019x16x22
1	25MM	MC5019x16x25

(See page 285 for sleeves and nuts.)

Male 37° JIC to Female FOR-SEAL®

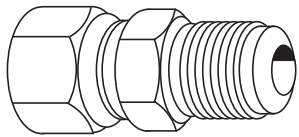

TUBE O.D.	TUBE O.D.	CATALOG NUMBER
1/4	1/4	4213x4
3/8	3/8	4213x6
1/2	1/2	4213x8
5/8	5/8	4213x10
3/4	3/4	4213x12
1	1	4213x16

37° JIC Female Swivel to Male Straight Thread O-Ring

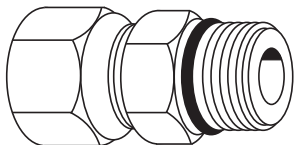

TUBE O.D.	PORT SIZE	CATALOG NUMBER
1/4	1/4	C5216x4x4
1/4	3/8	C5216x4x6
3/8	3/8	C5216x6x6
3/8	1/2	C5216x6x8
1/2	3/8	C5216x8x6
1/2	1/2	C5216x8x8
5/8	5/8	C5216x10x10
3/4	3/4	C5216x12x12
1	1	C5216x16x16
1-1/4	1-1/4	C5216x20x20
1-1/2	1-1/2	C5216x24x24
2	2	C5216x32x32

Female 37° JIC Swivel to Female Pipe

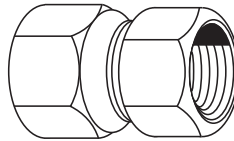

TUBE O.D.	PIPE SIZE	CATALOG NUMBER
1/4	1/4	C5256x4x4
3/8	3/8	C5256x6x6
1/2	1/2	C5256x8x8
3/4	3/4	C5256x12
1	1	C5256x16

Swivel Nut 45° Elbow (Ref. SAE No. 070321) Assembly Number C35356x4, etc.

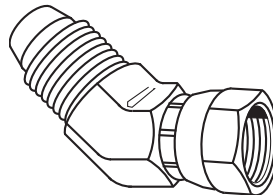

TUBE O.D.	CATALOG NUMBER
1/4	C5356x4
5/16	C5356x5
3/8	C5356x6□
1/2	C5356x8□
5/8	C5356x10
3/4	C5356x12
7/8	C5356x14
1	C5356x16
1-1/4	C5356x20 ¹
1-1/2	C5356x24
1/4	TF5356x4
5/16	TF5356x5
3/8	TF5356x6
1/2	TF5356x8
5/8	TF5356x10
3/4	TF5356x12
1	TF5356x16
1-1/4	TF5356x20
1-1/2	TF5356x24
2	TF5356x32

*5368x

¹Special order only.

45° Bulkhead Union Elbow

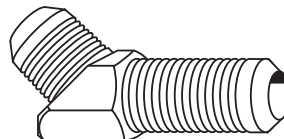

TUBE O.D.	CATALOG NUMBER
1/4	TF5375x4
5/16	TF5375x5
3/8	TF5375x6
1/2	TF5375x8
5/8	TF5375x10
3/4	TF5375x12
1	TF5375x16

*Stainless steel catalog number.

□ Available in Stainless Steel.

For bulkhead nut see page 257.
Included with assembly.

JIC 37° Flare-Twin®

45° Male Elbow (Ref. SAE No. 070302) Assembly Number C35355x4, etc.

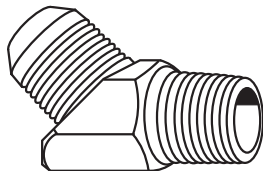
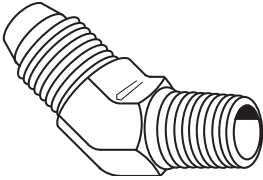

TUBE O.D.	MALE PIPE THREAD	CATALOG NUMBER
1/8	1/8	C5355x2
3/16	1/8	C5355x3
1/4	1/8	C5355x4□
1/4	1/4	C5355x4x4□
5/16	1/8	C5355x5
5/16	1/4	C5355x5x4
3/8	1/8	C5355x6x2
3/8	1/4	C5355x6□
3/8	3/8	C5355x6x6
3/8	1/2	C5355x6x8
1/2	1/4	C5355x8x4
1/2	3/8	C5355x8□
1/2	1/2	C5355x8x8□
5/8	3/8	C5355x10x6
5/8	1/2	C5355x10
3/4	1/2	C5355x12x8
3/4	3/4	C5355x12□
1	3/4	C5355x16x12
1	1	C5355x16
1-1/4	1-1/4	C5355x20 ¹
1-1/2	1-1/2	C5355x24
2	2	C5355x32
1/8	1/8	TF5355x2
1/4	1/8	TF5355x4
1/4	1/4	TF5355x4x4
5/16	1/8	TF5355x5
5/16	1/4	TF5355x5x4
3/8	1/8	TF5355x6x2
3/8	1/4	TF5355x6
3/8	3/8	TF5355x6x6
3/8	1/2	TF5355x6x8
1/2	1/4	TF5355x8x4
1/2	3/8	TF5355x8
1/2	1/2	TF5355x8x8
5/8	3/8	TF5355x10x6
5/8	1/2	TF5355x10
5/8	3/4	TF5355x10x12
3/4	1/2	TF5355x12x8

*5367x

¹Special order only.

*Stainless steel catalog number.
□ Available in Stainless Steel.

45° Male Elbow cont. (Ref. SAE No. 070302) Assembly Number C35355x4, etc.

TUBE O.D.	MALE PIPE THREAD	CATALOG NUMBER
3/4	3/4	TF5355x12
3/4	1	TF5355x12x16
1	3/4	TF5355x16x12
1	1	TF5355x16
1-1/4	1-1/4	TF5355x20
1-1/2	1-1/2	TF5355x24
2	2	TF5355x32

*5367x

Straight Thread O-Ring 45° Elbow (Ref. SAE No. 070320) Assembly Number C35365x4, etc.

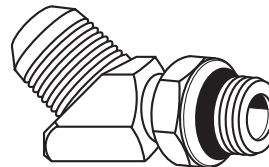
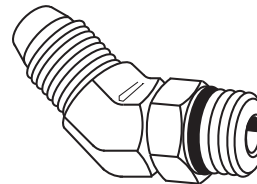

TUBE O.D.	PORT SIZE	CATALOG NUMBER
1/4	1/4	C5365x4
5/16	5/16	C5365x5 ¹
3/8	3/8	C5365x6
1/2	1/2	C5365x8
1/2	5/8	C5365x8x10
5/8	5/8	C5365x10
3/4	5/8	C5365x12x10
3/4	3/4	C5365x12
1	1	C5365x16
1-1/4	1-1/4	C5365x20
1-1/2	1-1/2	C5365x24 ¹
1/4	1/4	TF5365x4
5/16	5/16	TF5365x5
3/8	3/8	TF5365x6
3/8	1/2	TF5365x6x8
1/2	3/8	TF5365x8x6
1/2	1/2	TF5365x8
1/2	5/8	TF5365x8x10
5/8	1/2	TF5365x10x8
5/8	5/8	TF5365x10
5/8	3/4	TF5365x10x12
3/4	5/8	TF5365x12x10
3/4	3/4	TF5365x12
3/4	1	TF5365x12x16
7/8	7/8	TF5365x14
1	3/4	TF5365x16x12
1	1	TF5365x16
1-1/4	1-1/4	TF5365x20
1-1/2	1-1/2	TF5365x24
2	2	TF5365x32

*5377x

¹Special order only.

JIC 37° Flare-Twin®

Female 37° JIC Swivel to Male Pipe Adapter

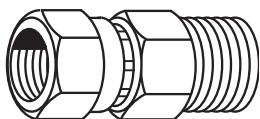

TUBE O.D.	MALE PIPE THREAD	CATALOG NUMBER
1/4	1/4	9100x4x4
5/16	1/4	9100x5x4
3/8	1/4	9100x6x4
3/8	3/8	9100x6x6
1/2	3/8	9100x8x6
1/2	1/2	9100x8x8
5/8	3/8	9100x10x6
5/8	1/2	9100x10x8
3/4	1/2	9100x12x8
3/4	3/4	9100x12x12
1	3/4	9100x16x12
1	1	9100x16x16
1-1/4	1-1/4	9100x20x20

90° Union Elbow (Ref. SAE No. 070201) Assembly Number C35505x4, etc.

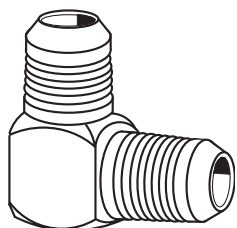
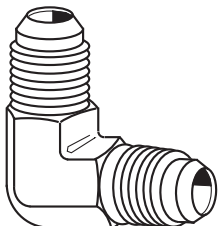

TUBE O.D.	CATALOG NUMBER
1/4	C5505x4□
5/16	C5505x5 ¹
3/8	C5505x6□
1/2	C5505x8□
5/8	C5505x10□
3/4	C5505x12□
1	C5505x16□
1-1/4	C5505x20 ¹
1-1/2	C5505x24 ¹
1/4	TF5505x4
5/16	TF5505x5
3/8	TF5505x6
1/2	TF5505x8
5/8	TF5505x10
3/4	TF5505x12
7/8	TF5505x14
1	TF5505x16
1-1/4	TF5505x20
1-1/2	TF5505x24
2	TF5505x32

*5517x

¹Special order only.

90° Bulkhead Union Elbow

(Ref. SAE No. 070701)
Assembly Number C35525x4,
etc.

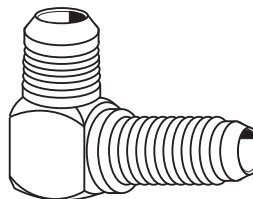
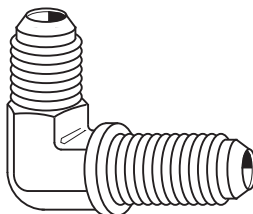

TUBE O.D.	CATALOG NUMBER
1/4	C5525x4□
5/16	C5525x5 ¹
3/8	C5525x6□
1/2	C5525x8
5/8	C5525x10 ¹
3/4	C5525x12□
1	C5525x16
1-1/4	C5525x20
1/4	TF5525x4
5/16	TF5525x5
3/8	TF5525x6
1/2	TF5525x8
5/8	TF5525x10
3/4	TF5525x12
1	TF5525x16

For bulkhead nut see page 257.
Included with assembly.

*5537x

¹Special order only.

*Stainless steel catalog number.

□ Available in Stainless Steel.

JIC 37° Flare-Twin®

90° Male Elbow
(Ref. SAE No. 070202)
Assembly Number C35405x4,
etc.

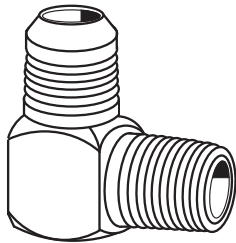
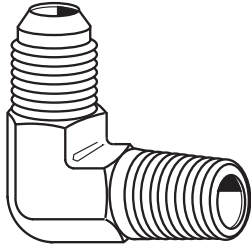

TUBE O.D.	MALE PIPE THREAD	CATALOG NUMBER	TUBE O.D.	MALE PIPE THREAD	CATALOG NUMBER
1/8	1/8	C5405x2□	5/16	1/8	TF5405x5
3/16	1/8	C5405x3	5/16	1/4	TF5405x5x4
1/4	1/8	C5405x4□	5/16	3/8	TF5405x5x6
1/4	1/4	C5405x4x4□	3/8	1/4	TF5405x6
5/16	1/8	C5405x5	3/8	1/8	TF5405x6x2
5/16	1/4	C5405x5x4□	3/8	3/8	TF5405x6x6
3/8	1/8	C5405x6x2□	3/8	1/2	TF5405x6x8
3/8	1/4	C5405x6□	3/8	3/4	TF5405x6x12
3/8	3/8	C5405x6x6□	1/2	1/4	TF5405x8x4
3/8	1/2	C5405x6x8□	1/2	3/8	TF5405x8
1/2	1/4	C5405x8x4□	1/2	1/2	TF5405x8x8
1/2	3/8	C5405x8□	1/2	3/4	TF5405x8x12
1/2	1/2	C5405x8x8□	5/8	3/8	TF5405x10x6
1/2	3/4	C5405x8x12□	5/8	1/2	TF5405x10
5/8	3/8	C5405x10x6	5/8	3/4	TF5405x10x12
5/8	1/2	C5405x10□	3/4	1/2	TF5405x12x8
5/8	3/4	C5405x10x12	3/4	3/4	TF5405x12
3/4	1/2	C5405x12x8□	3/4	1	TF5405x12x16
3/4	3/4	C5405x12□	7/8	3/4	TF5405x14
7/8	3/4	C5405x14 ¹	1	3/4	TF5405x16x12
1	3/4	C5405x16x12	1	1	TF5405x16
1	1	C5405x16□	1	1-1/4	TF5405x16x20
1-1/4	1	C5405x20x16	1-1/4	1	TF5405x20x16
1-1/4	1-1/4	C5405x20	1-1/4	1-1/4	TF5405x20
1-1/2	1-1/2	C5405x24	1-1/4	1-1/2	TF5405x20x24
2	2	C5405x32	1-1/2	1-1/4	TF5405x24x20
1/4	1/8	TF5405x4	1-1/2	1-1/2	TF5405x24
1/4	1/4	TF5405x4x4	2	2	TF5405x32
1/4	3/8	TF5405x4x6			
1/4	1/2	TF5405x4x8			

*5417x

¹Special order only.

*Stainless Steel Catalog number.

□ Available in Stainless Steel.

JIC 37° Flare-Twin®

90° Male Elbow Long

(Ref. SAE No. 071502)

Assembly Number C35425x4,
etc.

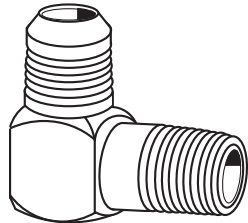
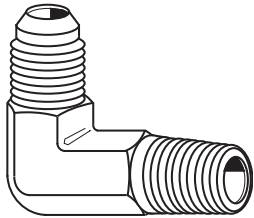

TUBE O.D.	MALE PIPE THREAD	CATALOG NUMBER
1/4	1/4	C5425x4x4 ¹
3/8	1/4	C5425x6
1/2	3/8	C5425x8 ¹
3/4	3/4	C5425x12
7/8	3/4	C5425x14 ¹
1/4	1/8	TF5425x4
1/4	1/4	TF5425x4x4
5/16	1/4	TF5425x5x4
3/8	1/4	TF5425x6
3/8	3/8	TF5425x6x6
1/2	3/8	TF5425x8
1/2	1/2	TF5425x8x8
1/2	3/4	TF5425x8x12
5/8	1/2	TF5425x10
3/4	3/4	TF5425x12
7/8	3/4	TF5425x14
7/8	3/4	TF5425x14x12
1	1	TF5425x16
1-1/4	1-1/4	TF5425x20
1-1/2	1-1/2	TF5425x24

¹Special order only.

90° Male Elbow Extra Long

(Ref. SAE No. 071602)

Assembly Number C35435x4,
etc.

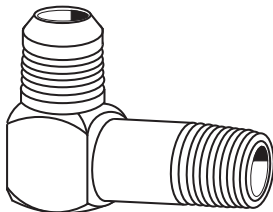

TUBE O.D.	MALE PIPE THREAD	CATALOG NUMBER
1/4	1/8	TF5435x4
1/4	1/4	TF5435x4x4
5/16	1/8	TF5435x5
5/16	1/4	TF5435x5x4
3/8	1/4	TF5435x6
3/8	3/8	TF5435x6x6
1/2	3/8	TF5435x8
1/2	1/2	TF5435x8x8
5/8	1/2	TF5435x10
3/4	3/4	TF5435x12
7/8	3/4	TF5435x14
1	1	TF5435x16
1-1/4	1-1/4	TF5435x20

90° Female Elbow

(Ref. SAE No. 070203)

Assembly Number
C35455x4, etc.

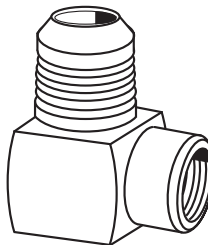
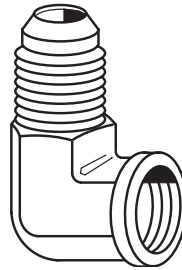

TUBE O.D.	FEM. PIPE THREAD	CATALOG NUMBER
1/4	1/8	C5455x4□
1/4	1/4	C5455x4x4 ¹
5/16	1/8	C5455x5 ¹
3/8	1/8	C5455x6x2
3/8	1/4	C5455x6□
3/8	3/8	C5455x6x6□
1/2	1/4	C5455x8x4
1/2	3/8	C5455x8□
1/2	1/2	C5455x8x8□
5/8	1/2	C5455x10
3/4	1/2	C5455x12x8
3/4	3/4	C5455x12□
7/8	3/4	C5455x14
1	1	C5455x16□
1-1/4	1-1/4	C5455x20 ¹
1/4	1/8	TF5455x4
1/4	1/4	TF5455x4x4
5/16	1/8	TF5455x5
5/16	1/4	TF5455x5x4
3/8	1/4	TF5455x6
3/8	3/8	TF5455x6x6
1/2	3/8	TF5455x8
1/2	1/2	TF5455x8x8
5/8	1/2	TF5455x10
3/4	3/4	TF5455x12
7/8	3/4	TF5455x14
1	1	TF5455x16
1-1/4	1-1/4	TF5455x20
1-1/2	1-1/2	TF5455x24
2	2	TF5455x32

*5467x

¹Special order only.

*Stainless Steel Catalog number.
□ Available in Stainless Steel.

JIC 37° Flare-Twin®

Swivel Nut 90° Elbow
(Ref. SAE No. 070221)
Assembly Number C35506x4,
etc.

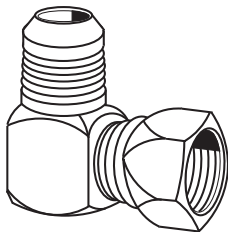
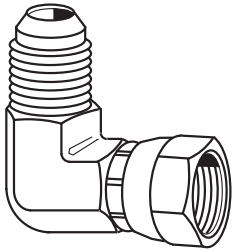

TUBE O.D.	CATALOG NUMBER
1/4	C5506x4□
5/16	C5506x5
3/8	C5506x6□
1/2	C5506x8□
5/8	C5506x10
3/4	C5506x12□
7/8	C5506x14 ¹
1	C5506x16□
1-1/4	C5506x20
1/4	TF5506x4
5/16	TF5506x5
3/8	TF5506x6
1/2	TF5506x8
5/8	TF5506x10
3/4	TF5506x12
7/8	TF5506x14
1	TF5506x16
1-1/4	TF5506x20
1-1/2	TF5506x24
2	TF5506x32

*5518x

¹Special order only.

90° Male Pipe to JIC 37° Swivel
Assembly Number
TF35406x4, etc.

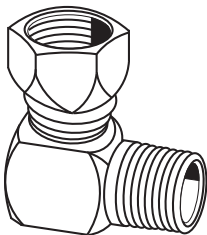

TUBE O.D.	MALE PIPE THREAD	CATALOG NUMBER
1/4	1/8	TF5406x4
3/8	1/4	TF5406x6
1/2	3/8	TF5406x8
5/8	1/2	TF5406x10
3/4	3/4	TF5406x12
1	1	TF5406x16
1-1/4	1-1/4	TF5406x20
1-1/2	1-1/2	TF5406x24
2	2	TF5406x32

Straight Thread O-Ring 90° Elbow (cont. on next page)
(Ref. SAE No. 070220)
Assembly Number C35515x4,
etc.

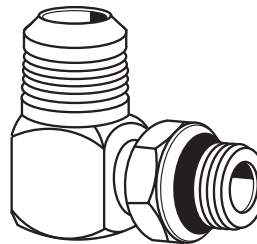
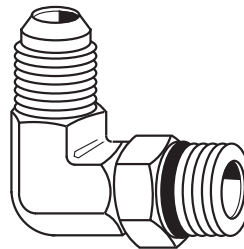

TUBE O.D.	PORT SIZE	CATALOG NUMBER
3/16	3/16	C5515x3
1/4	1/4	C5515x4□
5/16	5/16	C5515x5□
3/8	3/8	C5515x6□
3/8	1/2	C5515x6x8
1/2	3/8	C5515x8x6
1/2	1/2	C5515x8□
1/2	5/8	C5515x8x10
5/8	5/8	C5515x10
3/4	5/8	C5515x12x10
3/4	3/4	C5515x12□
7/8	7/8	C5515x14
1	3/4	C5515x16x12
1	1	C5515x16
1-1/4	1-1/4	C5515x20
1-1/2	1-1/2	C5515x24
1/4	1/4	TF5515x4
1/4	5/16	TF5515x4x5
1/4	3/8	TF5515x4x6
5/16	1/4	TF5515x5x4
5/16	5/16	TF5515x5
5/16	3/8	TF5515x5x6
3/8	1/4	TF5515x6x4
3/8	5/16	TF5515x6x5
3/8	3/8	TF5515x6
3/8	1/2	TF5515x6x8
3/8	5/8	TF5515x6x10
1/2	3/8	TF5515x8x6
1/2	1/2	TF5515x8
1/2	5/8	TF5515x8x10
1/2	3/4	TF5515x8x12
5/8	1/2	TF5515x10x8
5/8	5/8	TF5515x10
5/8	3/4	TF5515x10x12
3/4	1/2	TF5515x12x8
3/4	5/8	TF5515x12x10

*5527x

*Stainless Steel Catalog number.
□ Available in Stainless Steel.

JIC 37° Flare-Twin®

**Straight Thread O-Ring
90° Elbow (cont. from
previous page)**
(Ref. SAE No. 070220)
Assembly Number C35515x4,
etc.

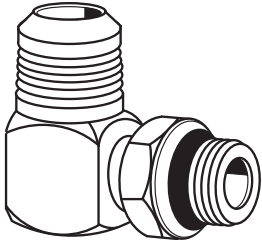

TUBE O.D.	PORT SIZE	CATALOG NUMBER
3/4	3/4	TF5515x12
3/4	7/8	TF5515x12x14
3/4	1	TF5515x12x16
1	3/4	TF5515x16x12
1	7/8	TF5515x16x14
1	1	TF5515x16
1	1-1/4	TF5515x16x20
1-1/4	1	TF5515x20x16
1-1/4	1-1/4	TF5515x20
1-1/2	1-1/4	TF5515x24x20
1-1/2	1-1/2	TF5515x24
2	2	TF5515x32

*5527x

**Straight Thread O-Ring
90° Elbow Long**
(Ref. SAE No. 071620)

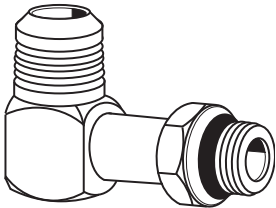

TUBE O.D.	PORT SIZE	CATALOG NUMBER
3/8	3/8	TF5515x6L
1/2	1/2	TF5515x8L
5/8	5/8	TF5515x10L
3/4	3/4	TF5515x12L

**Straight Thread O-Ring
90° Elbow Extra Long**
(Ref. SAE No. 071620)

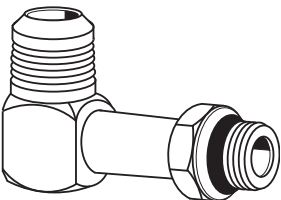

TUBE O.D.	PORT SIZE	CATALOG NUMBER
3/8	3/8	TF5515x6LL
1/2	1/2	TF5515x8LL
5/8	5/8	TF5515x10LL
3/4	3/4	TF5515x12LL

Union Tee
(Ref. SAE No. 070401)
Assembly Number C35705x4,
etc.

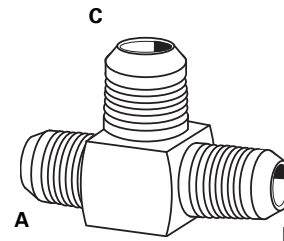
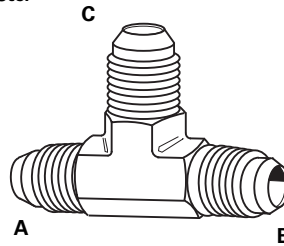

TUBE O.D. A	TUBE O.D. B	TUBE O.D. C	CATALOG NUMBER
1/8	1/8	1/8	C5705x2
3/16	3/16	3/16	C5705x3
1/4	1/4	1/4	C5705x4□
5/16	5/16	5/16	C5705x5 ¹
3/8	3/8	3/8	C5705x6□
1/2	1/2	1/2	C5705x8□
5/8	5/8	5/8	C5705x10□
3/4	3/4	3/4	C5705x12□
7/8	7/8	7/8	C5705x14
1	1	1	C5705x16
1-1/4	1-1/4	1-1/4	C5705x20
1-1/2	1-1/2	1-1/2	C5705x24
1/4	1/4	1/4	TF5705x4
5/16	5/16	5/16	TF5705x5
3/8	3/8	3/8	TF5705x6
1/2	1/2	1/2	TF5705x8
5/8	1/2	1/2	TF5705x10x8x8
5/8	5/8	5/8	TF5705x10
5/8	5/8	1/2	TF5705x10x10x8
3/4	3/4	3/4	TF5705x12
7/8	7/8	7/8	TF5705x14
1	1	1	TF5705x16
1-1/4	1-1/4	1-1/4	TF5705x20
1-1/2	1-1/2	1-1/2	TF5705x24
2	2	2	TF5705x32

*5717x

¹Special order only.

*Stainless Steel Catalog number.
□ Available in Stainless Steel.

JIC 37° Flare-Twin®

Male Run Tee (Ref. SAE No. 070424)

Assembly Number C35755x4,
etc.

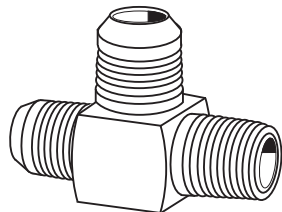
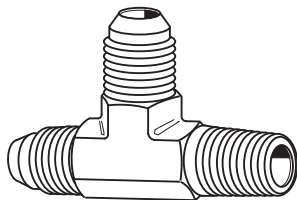

TUBE O.D.	MALE PIPE THREAD	CATALOG NUMBER
1/4	1/8	C5755x4□
1/4	1/4	C5755x4x4x4 ¹
3/8	1/4	C5755x6 ¹ □
1/2	3/8	C5755x8□
1/2	1/2	C5755x8x8x8 ¹
5/8	1/2	C5755x10
3/4	3/4	C5755x12
1	1	C5755x16
1/4	1/8	TF5755x4
1/4	1/4	TF5755x4x4x4
5/16	1/8	TF5755x5
3/8	1/4	TF5755x6
3/8	3/8	TF5755x6x6x6
1/2	3/8	TF5755x8
1/2	1/2	TF5755x8x8x8
5/8	1/2	TF5755x10
3/4	3/4	TF5755x12
7/8	3/4	TF5755x14
1	1	TF5755x16
1-1/4	1-1/4	TF5755x20
1-1/2	1-1/2	TF5755x24
2	2	TF5755x32

*5767x

¹Special order only.

Female Run Tee (Ref. SAE No. 070426)

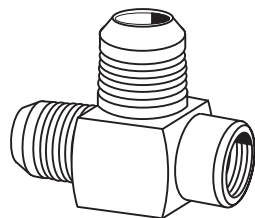

TUBE O.D.	FEM. PIPE THREAD	CATALOG NUMBER
1/4	1/8	TF5805x4
3/8	1/4	TF5805x6
1/2	3/8	TF5805x8
5/8	1/2	TF5805x10
3/4	3/4	TF5805x12
7/8	3/4	TF5805x14
1	1	TF5805x16

Swivel Nut Run Tee (Ref. SAE No. 070432)

Assembly Number C35706x4,
etc.

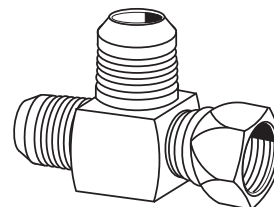
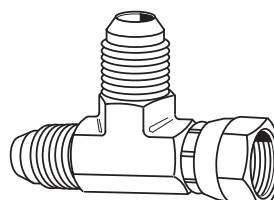

TUBE O.D.	CATALOG NUMBER
1/4	C5706x4□
5/16	C5706x5
3/8	C5706x6□
1/2	C5706x8□
5/8	C5706x10
3/4	C5706x12□
1	C5706x16
1-1/4	C5706x20
1/4	TF5706x4
5/16	TF5706x5
3/8	TF5706x6
1/2	TF5706x8
5/8	TF5706x10
3/4	TF5706x12
7/8	TF5706x14
1	TF5706x16
1-1/4	TF5706x20
1-1/2	TF5706x24
2	TF5706x32

*5718x

Bulkhead Run Tee (Ref. SAE No. 070958)

Assembly Number C35726x4,
etc.

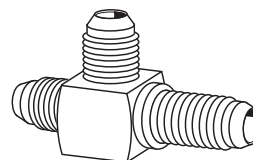
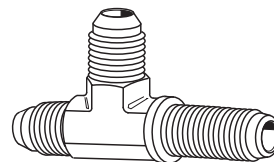

TUBE O.D.	CATALOG NUMBER
3/8	C5726x6
1/2	C5726x8 ¹
1/2	TF5726x8

For bulkhead nut see page 270.
Included with assembly.

¹Special order only.

*Stainless Steel Catalog number.

□ Available in Stainless Steel.

JIC 37° Flare-Twin®

Straight Thread O-Ring Run Tee

(Ref. SAE No. 070428)

Assembly Number C35716x4,
etc.

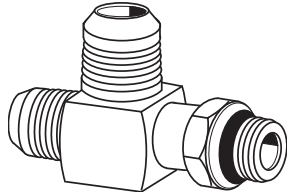
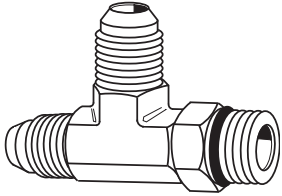

TUBE O.D.	PORT SIZE	CATALOG NUMBER
1/4	1/4	C5716x4
5/16	5/16	C5716x5
3/8	3/8	C5716x6
1/2	1/2	C5716x8
5/8	5/8	C5716x10
3/4	3/4	C5716x12
1	1	C5716x16
1-1/4	1-1/4	C5716x20
1/4	1/4	TF5716x4
5/16	5/16	TF5716x5
3/8	3/8	TF5716x6
1/2	1/2	TF5716x8
5/8	5/8	TF5716x10
3/4	3/4	TF5716x12
7/8	7/8	TF5716x14
1	1	TF5716x16
1-1/4	1-1/4	TF5716x20
1-1/2	1-1/2	TF5716x24

Replacement O-rings page 254.

Male Branch Tee (Ref. SAE No. 070425)

Assembly Number C35605x4,
etc.

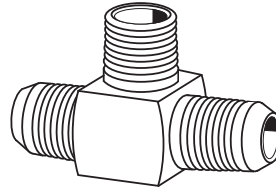
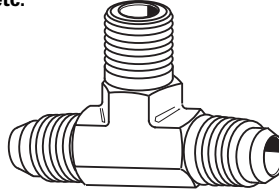

TUBE O.D.	MALE PIPE THREAD	CATALOG NUMBER
1/4	1/8	C5605x4□
1/4	1/4	C5605x4x4x4
5/16	1/8	C5605x5
3/8	1/4	C5605x6□
1/2	3/8	C5605x8
5/8	1/2	C5605x10
3/4	3/4	C5605x12
7/8	3/4	C5605x14 ¹
1	1	C5605x16
1-1/4	1-1/4	C5605x20 ¹
1/4	1/8	TF5605x4
1/4	1/4	TF5605x4x4x4
5/16	1/8	TF5605x5
3/8	1/4	TF5605x6
3/8	3/8	TF5605x6x6x6
1/2	3/8	TF5605x8
1/2	1/2	TF5605x8x8x8
5/8	1/2	TF5605x10
3/4	3/4	TF5605x12
7/8	3/4	TF5605x14
1	1	TF5605x16
1-1/4	1-1/4	TF5605x20
1-1/2	1-1/2	TF5605x24
2	2	TF5605x32

*5617x

¹Special order only.

*Stainless Steel Catalog number.
□ Available in Stainless Steel.

JIC 37° Flare-Twin®

Female Branch Tee (Ref. SAE No. 070427)

Assembly Number C35655x4,
etc.

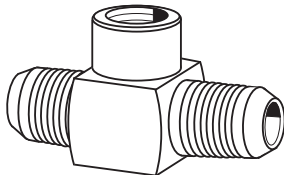
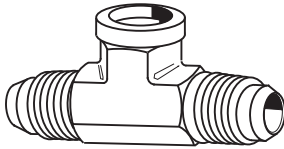

TUBE O.D.	FEM. PIPE THREAD	CATALOG NUMBER
1/4	1/8	C5655x4□
3/8	1/4	C5655x6□
1/2	3/8	C5655x8□
5/8	1/2	C5655x10
3/4	3/4	C5655x12
1	1	C5655x16 ¹
1/4	1/8	TF5655x4
1/4	1/4	TF5655x4x4x4
5/16	1/8	TF5655x5
3/8	1/4	TF5655x6
3/8	3/8	TF5655x6x6x6
1/2	3/8	TF5655x8
1/2	1/2	TF5655x8x8x8
5/8	1/2	TF5655x10
3/4	3/4	TF5655x12
7/8	3/4	TF5655x14
1	1	TF5655x16
1-1/4	1-1/4	TF5655x20
1-1/2	1-1/2	TF5655x24
2	2	TF5655x32

*5667x

¹Special order only.

Swivel Nut Branch Tee (Ref. SAE No. 070433)

Assembly Number C35707x4,
etc.

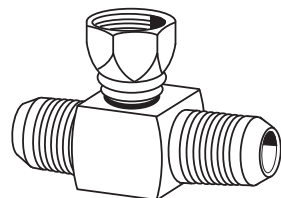
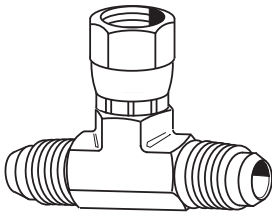

TUBE O.D.	CATALOG NUMBER
1/4	C5707x4
3/8	C5707x6
1/2	C5707x8
3/4	C5707x12
1	C5707x16
1/4	TF5707x4
5/16	TF5707x5
3/8	TF5707x6
1/2	TF5707x8
5/8	TF5707x10
3/4	TF5707x12
7/8	TF5707x14
1	TF5707x16
1-1/4	TF5707x20
1-1/2	TF5707x24
2	TF5707x32

*5719x

¹Special order only.

Bulkhead Branch Tee (Ref. SAE No. 070959)

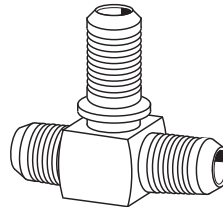
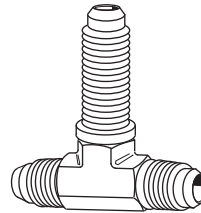

TUBE O.D.	CATALOG NUMBER
1/4	5737x4#
3/8	5737x6#
1/4	TF5725x4
3/8	TF5725x6
1/2	TF5725x8
5/8	TF5725x10
3/4	TF5725x12
1	TF5725x16

#Stainless steel construction. For bulkhead nut see page 257. Included with assembly.

Straight Thread O-Ring Branch Tee (Ref. SAE No. 070429)

Assembly Number C35715x4,
etc.

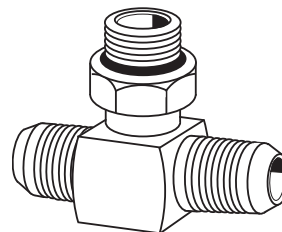
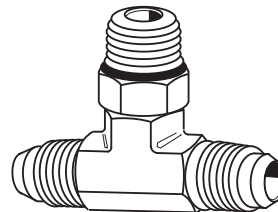

TUBE O.D.	PORT SIZE	CATALOG NUMBER
1/4	1/4	C5715x4
5/16	5/16	C5715x5
3/8	3/8	C5715x6
1/2	1/2	C5715x8
5/8	5/8	C5715x10
3/4	3/4	C5715x12
1	1	C5715x16
1/4	1/4	TF5715x4
5/16	5/16	TF5715x5
3/8	3/8	TF5715x6
1/2	1/2	TF5715x8
5/8	5/8	TF5715x10
3/4	3/4	TF5715x12
7/8	7/8	TF5715x14
1	1	TF5715x16
1-1/4	1-1/4	TF5715x20
1-1/2	1-1/2	TF5715x24

*Stainless Steel Catalog number.

□ Available in Stainless Steel.

JIC 37° Flare-Twin®

Cross (Ref. SAE No. 070501)

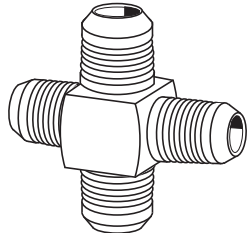
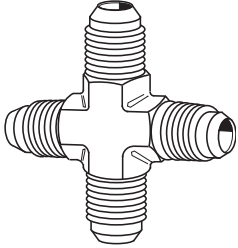

TUBE O.D.	CATALOG NUMBER
1/4	5967x4#
3/8	5967x6#
1/2	5967x8#
1/4	TF5955x4
5/16	TF5955x5
3/8	TF5955x6
1/2	TF5955x8
5/8	TF5955x10
3/4	TF5955x12
7/8	TF5955x14
1	TF5955x16
1-1/4	TF5955x20
1-1/2	TF5955x24

#Stainless steel construction.

Straight Thread O-Ring

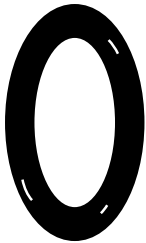

Material: Buna-N
90 Durometer

Temperature Range:
-40°F to +250°F
(-40°C to +121°C)

Standard O-ring complies with SAE specification SAE J515 Type CH.
(See page 247 for O-ring compound and application chart)

PORT SIZE	CATALOG NUMBER
1/16	7629x1
1/8	7629x2
3/16	7629x3
1/4	7629x4
5/16	7629x5
3/8	7629x6
7/16	7629x7
1/2	7629x8
5/8	7629x10
3/4	7629x12
7/8	7629x14
1	7629x16
1-1/4	7629x20
1-1/2	7629x24
2	7629x32